

EN Operating manual

High-pressure cleaner

Quickly



Operating manual

EN

High-pressure cleaner

Quickly

Operating manual!

This manual is a translation of the original manual. Read and conform safety instructions before use! Technical data will be found in the Spare parts list. Please be aware that the spare part list is part of the operating manual. Keep both leaflets for later use or any subsequent owners.

Dear customer:

We would like to congratulate you on the purchase of your new high-pressure cleaner and thank you for your confidence in our products. Your choice has fallen on an absolute quality product!

Kränzle high-pressure cleaners are characterized by their convenient and compact design as well as their high suitability for everyday use. Highest precision and dimensional accuracy in addition to a technology package consisting of a multitude of details mark the difference when it comes to performance, safety and durability.

In order to facilitate handling of the high-pressure cleaner, the following pages are intended to further explain its use. The figures may be subject to deviation depending on the type of equipment or accessory purchased by you.

Contents	4
Explanatory symbols	5
Safety precautions	6
General rules	9
Description of high-pressure cleaner	10
Functional details	12
Putting into operation	16
Taking out of operation	20
Small repairs - do it yourself!	21
EU Declaration of Conformity	25
Warranty	26
Floor cleaner Round Cleaner UFO light	27
Kränzle accessories	34

Symbols used in the operating instructions



Failure to observe this note may entail environmental damage.



Note on using the high-pressure cleaner. Failure to comply may lead to excessive wear or even total failure of the Quickly.



Warning! Failure to observe this note may result in serious injuries!

Explanatory symbols affixed to the high-pressure cleaner



In case of improper use, the high-pressure jets can be very dangerous. In case of improper use, the high-pressure jets can be very dangerous. Do not direct jet at persons, animals or active electrical equipment or the high-pressure cleaner itself.



The high-pressure cleaner may not be connected directly to the public drinking water supply network.



Risk of burns due to hot surfaces!



Products marked with this symbol may contain constituents posing a risk to health or the environment if incorrectly disposed of. These products must never be disposed of as household waste.

Explanatory symbols used on packaging



This symbol denotes recyclable packaging materials which must not be disposed of as household waste. Information on proper disposal will be gathered from the recycling directives issued by your local authority.

Persons operating the machine should wear the necessary protective clothing, i.e. safety goggles, headwear etc. It must be ensured that the high-pressure cleaner is only operated in the presence of persons without sufficient protective clothing and at a sufficient distance.

Use of high-pressure cleaners may result in aerosols being generated. An aerosol is a mixture of floating solid or liquid particles in a gas. Inhaling aerosol particles may cause damage to health. The emission of aqueous aerosols can be noticeably reduced if using fully shielded spray nozzles (as for instance on the floor-scrubber/round cleaner). If the use of fully shielded spray nozzles is not possible, a respiratory mask should be worn, Class FFP 2 or higher (depending on the environment due to be cleaned).

Whenever the high-pressure cleaner is left unattended, **the mains disconnect switch must always be switched off.**

Asbestos and other materials containing hazardous substances must not be sprayed!

Never spray flammable liquids or liquids containing solvents such as paint thinners, petrol, oil or similar liquids! Explosion hazard due to spraying such materials!

Due to the high-pressure jet, damage may occur on the objects to be cleaned, e.g. car tires. Therefore, a minimum distance of 30 cm is to be kept!

Prior to putting the high-pressure cleaners into operation, check its components (HP hose, power supply cables, safety trigger gun) for any damage. Replace defect or damaged components!

Only use original Kränzle high-pressure hoses, couplings, fittings and spare parts. They guarantee the safety of the appliance.

If use is made of an extension cable, this must be suitable for outdoor use. In addition care needs to be taken to ensure that the cable is kept dry and that it is situated above the ground. We recommend the use of a cable drum capable of keeping the socket at least 60 mm above the ground.

Replacement of the power supply cables is only permitted by use of an original power supply cable of the manufacturer and must be performed by a qualified electrician.

Safety devices serve to protect the user and must never be de-activated or their function bypassed.

The high pressure cleaner is to be properly used. The user is required to adhere to local requirements and to watch out for any persons in the danger zone.

If used in elevated positions where there is a risk of the unit falling to the ground, it must be secured against rolling away or tipping over.

The high-pressure cleaner is not designed for use by persons with restricted physical, sensory or mental abilities (including children)!

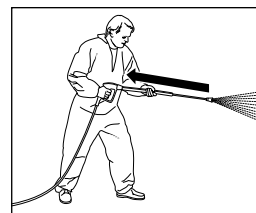

When using high-pressure water for cleaning, make sure that there is a clearly noticeable recoil effect on the lance. Therefore ensure a firm footing (see technical data).

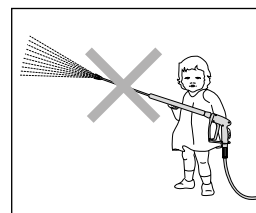

Never allow children or untrained persons to use the high-pressure cleaner or to play with it! Children must be kept under supervision to prevent them from playing with the equipment.

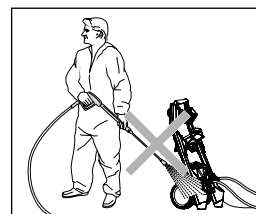

Never direct the water jet at the high pressure cleaner itself! The high pressure cleaner may not be placed within reach of the water jet spray mist!

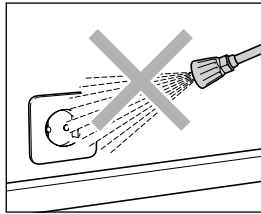

Do not direct the high-pressure jet at sockets or other electrical equipment! Within the working area, all live parts are to be protected from both water jet and spray mist.

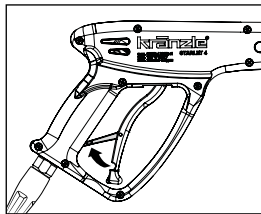

Apply the safety catch on the spray gun after each use in order to prevent unintentional spraying!

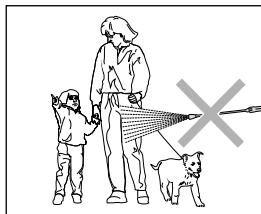

Do not direct the high-pressure jet at people or animals! Never direct the high-pressure jet at yourself or other persons, not even to clean clothing or shoes.

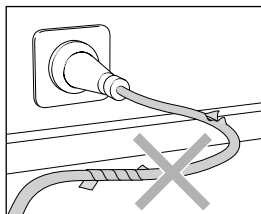

Only use a power supply cable in perfect working order! Do not damage or improperly repair the power cable (tearing, squeezing, running over, ...).

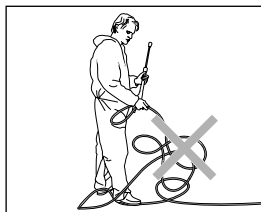

Never pull the high-pressure hose if it has formed kinks or "nooses"! Never pull the hose over sharp edges!

Intended Use

This high-pressure cleaner is to be used solely for high-pressure water jet cleaning applications without detergents or low-pressure cleaning work with detergents (e.g. with a foam lance or washing brush). It is solely designed for home users for typical applications around the house and garden (for cleaning facades, terraces, garden equipment, tools, vehicles and machinery as well as building structures). It is not intended for commercial use.



Environmental, refuse disposal and water protection regulations must be observed!

Inspections

Whenever necessary and at least once every 12 months, the high-pressure cleaner needs to be inspected by a qualified expert to ensure that it is still safe to operate.

Accident prevention

The high-pressure cleaner is designed for accidents to be impossible if used correctly. The user must be made aware of the risk of injury from hot machine parts and the high-pressure jet. The "Guidelines for Liquid Spray Devices" must be complied with.



Oil leakage

If oil leaks contact your nearest after-sales service (dealer) at once. Failure to observe this instruction may cause damage to the environment and/or transmission gearbox.

Structure: Quickly (with holder for 8 m high-pressure hose)

The Quickly is a mobile high-pressure cleaner with an advanced arrangement system. Please see construction scheme for more details.

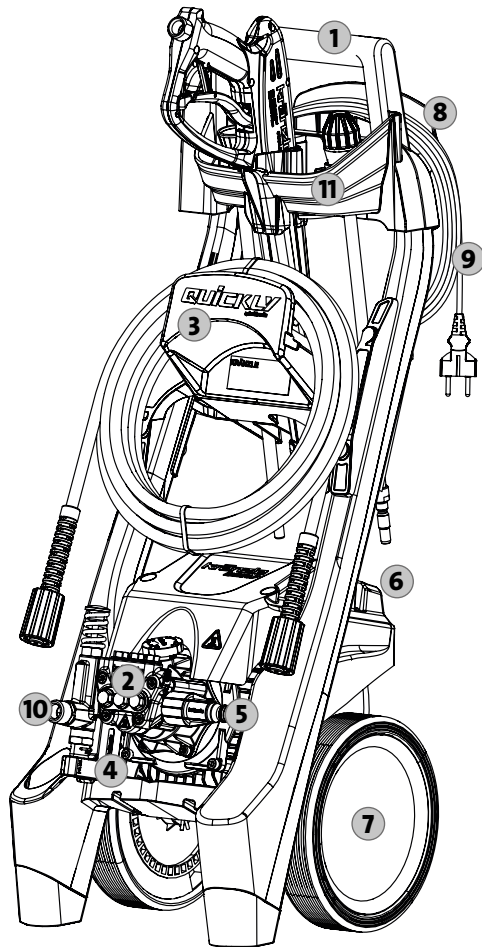

- 1 Ergonomically shaped handlebar
- 2 Pump head made of special brass
- 3 Holder for 8 m high-pressure hose
- 4 Totalstop
- 5 Supply water inlet sieve with filter
- 6 On/Off switch
- 7 Large stair climbing wheels
- 8 Cable reel for the power supply cable
- 9 Power supply cable with mains plug
- 10 Pump outlet / high-pressure hose connection
- 11 Accessory storage

This is what you have purchased

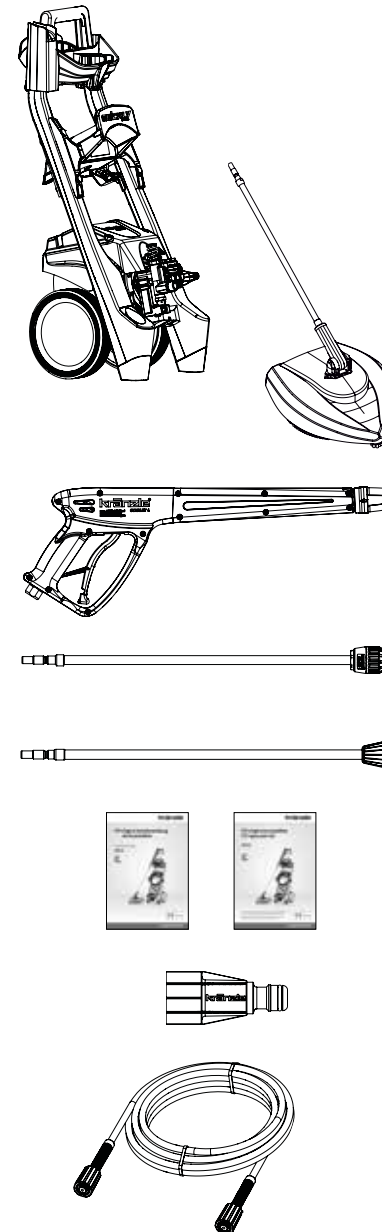

- 1. Kränzle high-pressure cleaner Quickly
- 2. Round Cleaner UFO
- 3. Trigger gun with safety catch with plug coupling
- 4. Dirtkiller lance with stainless steel pipe and plug-in nipple
- 5. Stainless steel lance with flat-jet nozzle and plug-in nipple
- 6. Operating manual
Spare parts list
- 7. Water inlet sieve, plug coupling with visible filter
- 8. High-pressure hose

Please note - important: Lack of water

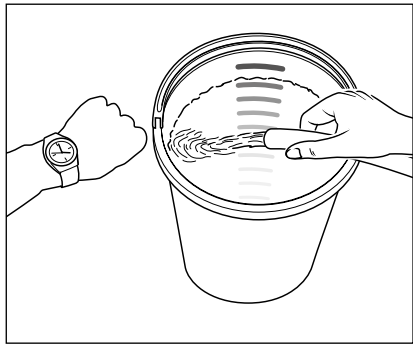

Lack of water occurs more often than you probably believe. The more powerful a high-pressure cleaner is the greater is the danger that a lack of water occurs. If there is only an insufficient amount of water available, cavitation (water-gas mixture) arises inside the high-pressure pump, which is normally noticed too late or even not at all. **The high-pressure pump will be destroyed.** Please check the available quantity of water by filling a bucket with liter scale for one minute.

Required minimum quantity of water (see technical data).



If the metered quantity of water is too small, you have to use a different water connection, guaranteeing the necessary output. Lack of water leads to an accelerated wear of the joints (guarantee void).



Never let the high-pressure pump run dry for more than 60 seconds.

Water supply



Please pay attention to the regulations of your waterworks company! In accordance with DIN EN 61770, the high-pressure cleaner may not be directly connected to the public drinking water supply lines. A brief connection however is permissible according to DVGW (German Association for Gas and Water Affairs) if a non-return valve with tube ventilator (Kränzle item no.: 410164) is built into the water supply. **Once the water has passed through the non-return valve it is no longer considered as drinking water.** Also indirect connection to the public drinking water supply lines is permissible by way of free emission in accordance with EN 61 770; e.g. by using a reservoir with a float valve. Direct connection to a non-drinking water supply line is permissible.

Insufficient quantity of electricity

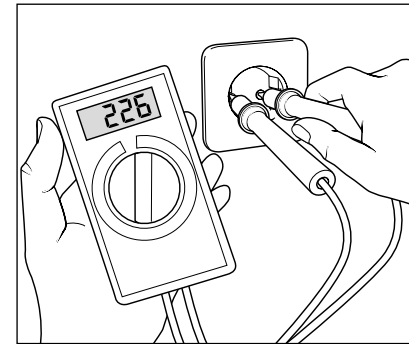

If there are too many collectors in your proximity connected to the network at the same time, the available voltage and the current intensity may decline. Consequently the motor of the high-pressure cleaner does not start or even blows. The power supply may also be insufficient if the power cable is too long or too thin. If extension cables are too long, this may lead to a voltage drop causing malfunctions or start-up difficulties.



Check the line fusing and have the voltage and the available current intensity checked by an expert in case of uncertainty (see technical data).

Electrical connection

The high-pressure cleaner is supplied with a power supply cable. The mains plug must be fitted to a standard grounded socket with a **30 mA** residual current operated device. Connection up to the mains must be carried out by a properly trained electrician and must comply with the requirements of IEC60364-1.

The socket must be protected with a **16 A delay action (Type B, C)** fuse on the mains side.

When using an extension cable, **this must have an earthed lead** which is properly connected to the socket. The conductors in the extension cable must have a minimum cross section of **2.5 mm²**. Plug connections must be of a spray-proof design, and may not be located on a wet floor. When using a cable drum, the power supply cable always must be unwound all the way.

Water and cleaning system

The water must be supplied to the high-pressure pump under line pressure. Then, the water is sucked by the high-pressure pump and supplied to the safety jet pipe under pressure. The high-pressure jet is formed by the nozzle at the end of the safety jet pipe.



Environmental, refuse disposal and water protection regulations must be observed!

Safety jet pipe with safety deactivation trigger gun

The high-pressure cleaner can only be operated when the trigger of the safety deactivation trigger gun's trigger is actuated. When the trigger is pulled, the safety deactivation trigger gun opens. The liquid is then transported to the nozzle. The spray pressure increases and quickly reaches the operating pressure. When the trigger is released, the safety deactivation trigger gun closes and any further spraying of liquid from the safety jet pipe is prevented. The pressure thrust serves to close the start/stop system, thus interrupting the energy supply to the motor. Pressing the trigger closes the start-stop system, the motor is automatically switched on again and the high-pressure pump delivers the water to the nozzle, where the high-pressure jet is formed.



The trigger gun with safety catch is a safety device. Repairs should only be performed by qualified persons. Should replacement parts be required, use only components authorized by the manufacturer.



Replacements, repairs, new adjustments and sealing should only be performed by qualified persons.



Prior to putting the machine into operation make sure that all safety instructions be observed.

Motor protection switch

Motor is protected against overload by means of a motor protection switch. If the motor is overloaded or blocked, the high-pressure cleaner switches off. If the motor switches off repeatedly, eliminate the cause of the fault.



Replacements and inspection work should only be performed by qualified persons when the machine is disconnected from the power supply, i.e. with plug pulled out from the electrical socket.

Total stop system

The Quickly is equipped with a total stop system. If the main switch is switched on, the motor is started via a pressure switch when opening the trigger gun with safety catch. When closing the safety trigger gun the motor is switched off immediately.

high-pressure hose and spray device

The high-pressure hose and spray device which are part of the Quickly equipment, are made of high-quality material and engineered to conform with the operating conditions of the high-pressure cleaner and are duly labelled.



If replacement parts are required, only such genuine spare parts that are authorised by the manufacturer may be used. The warranty is automatically void if spare parts of third-party providers are used! The high-pressure hose and spray device must be connected in a pressure-tight manner (without leakage).



The high-pressure hose may not be driven over, pulled excessively, or twisted. The high-pressure hose may under no circumstances be pulled over sharp edges. Defective high-pressure hoses must not be repaired (acc. to DIN 20022) but must be replaced by new hoses approved by the Kränzle.

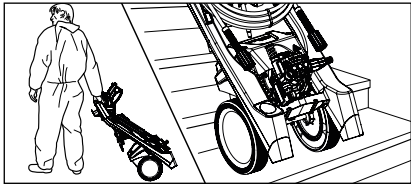

1. Move high-pressure cleaner to the job site. The Quickly is a movable high-pressure cleaner with sturdy trolleys ideally suited for difficult terrain.

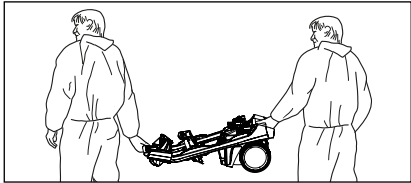

2. Owing to its light weight and handy size, the Quickly can be easily carried by two persons.



When carrying the Quickly, make sure to bear in mind the weight of the high-pressure cleaner (see technical data).



Neither set up or operate the Quickly in rooms where there is a risk of fire or explosion nor put it into puddles. Do not use the high-pressure cleaner under water. If, none the less, the high-pressure cleaner is operated in a hazardous area, the applicable safety regulations are to be observed.

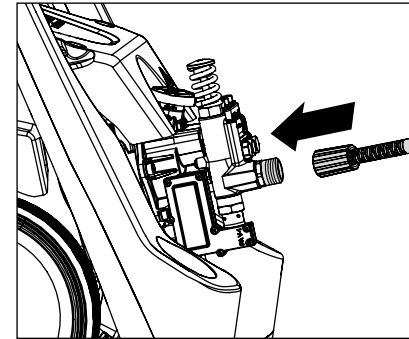

3. For high-pressure cleaners without hose drum the high-pressure hose included in the scope of the delivery must be screwed with the pump outlet in a tight and pressure tight manner. Unwind high-pressure hose straight and without nooses. The high-pressure hose may leave signs of abrasion on some floors. Alternatively, please also find non-marking high-pressure hoses in our range.

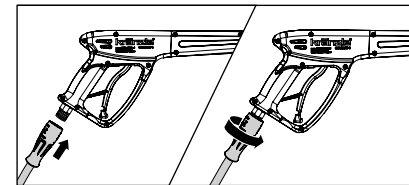

4. Tightly screw together high-pressure hose and trigger gun with safety catch.

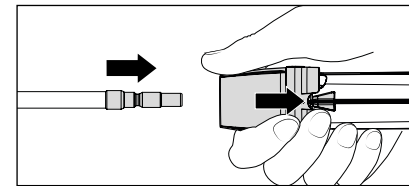

5. First pull back the retaining sleeve of the trigger gun with safety catch, then insert lance into the plug coupling connection of the gun.

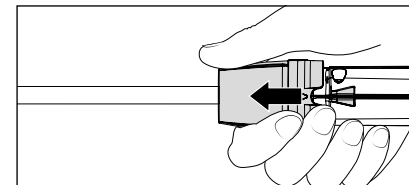

6. After insertion of the lance, release retaining sleeve and make sure that the lance is in a secure position.
Grease quick release nipple regularly using acid-free grease.



The plug coupling must not be actuated/handled during operation! High risk of injury!



Check the plug-in coupling and plug nipple for cleanliness (sand, dirt, ...) before inserting, clean with clear water if necessary. Contamination can damage the seal in the plug-in coupling.



When extending the high-pressure hose please consider the maximum length of 20 m!



Accessories may only be connected to a Kränzle-approved trigger gun with safety catch.

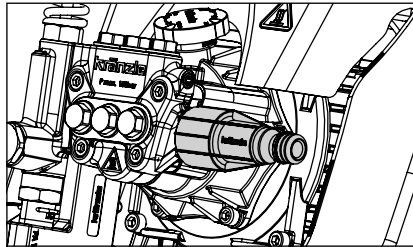

- 7. Check water sieve filter for cleanliness prior to putting the machine into operation.** When inside filter is contaminated, remove filter and follow step 7.1.
If the screen is dirty, no water can run through and no pressure can build up.

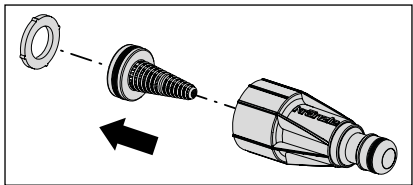

- 7.1** If contaminated, remove the filter and thoroughly rinse it with clear water and clean it with the other parts.



Check the water inlet sieve for damage. Do not operate the high-pressure cleaner without or with a damaged filter.

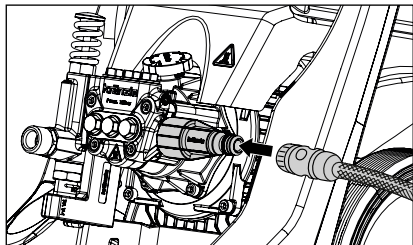

- 8.** Connect the water hose to water inlet sieve (minimum requirements: 5 m hose length, cross-section 3/4", 10 bar). The high-pressure cleaner may be connected to a water mains (1-10 bar pre-pressure) with either cold or hot water (up to 40 °C).



Be careful when using hot water!

When running your high-pressure cleaner with hot water of 40 °C raised temperatures occur. Do not touch the metal parts of the high-pressure cleaner without safety gloves!

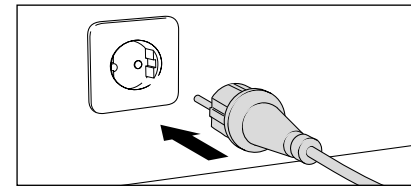

- 9.** Connect to circuit (see technical data).



Do not touch the mains plug or any live parts with wet or moist hands.

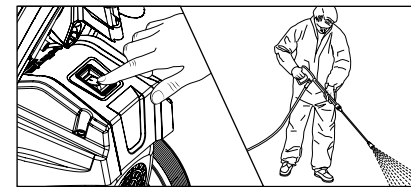

- 10.** Switch on high pressure cleaner with opened trigger gun with safety catch (trigger pulled). Bleeding of the HP cleaner: Pull and release trigger of trigger gun with safety catch several times. Start with cleaning process.

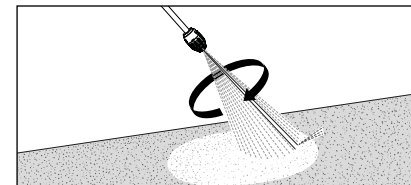

- 11.** When using the Dirtkiller, ensure that the lance is pointing down for start-up.

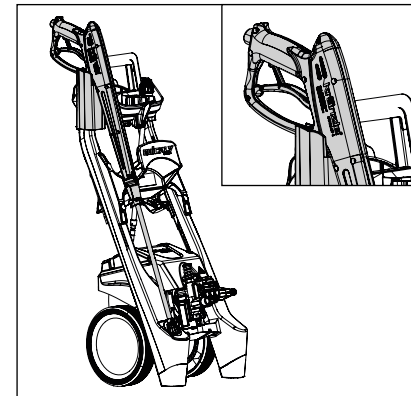

- 12.** The Quickly features a holder for holding the trigger gun with safety catch and lance during work breaks.



It is imperative that safety instructions be observed during use of the high-pressure cleaner.

1. Switch off the high-pressure cleaner
2. Cut off the water supply
3. Open the trigger gun with safety catch briefly until the pressure is released
4. Apply safety catch on the trigger gun
5. Unscrew the high-pressure hose from the trigger gun with safety catch
6. Emptying high-pressure pump: Hold high-pressure hose and switch motor on until water jet stops escaping at the outlet.
7. Pull out the mains plug
8. Clean high-pressure hose and wind up without loops
9. Clean and wind up the power supply cable
10. Clean the water inlet sieve
11. Store high-pressure cleaners in frost-free rooms in winter

Frost protection

For protecting the high-pressure cleaner against frost please empty it completely. Separate high-pressure cleaner from water supply and switch it on. By opening the trigger gun with safety catch the high-pressure pump presses water out of the high-pressure cleaner. **However, do not allow the device to operate without water for more than one minute.**

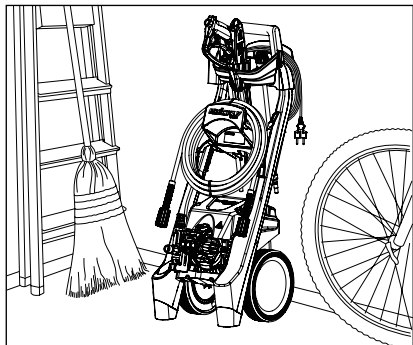

Due to their small base, the compact and mobile Kränzle the high pressure cleaners are easy to store.

Problem

No water from nozzle although the high-pressure cleaner is running.

Cause

Most likely the nozzle is blocked.

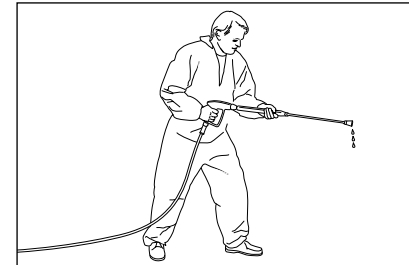

No or very little water from the lance.

Proceeding:

Switch off the cleaner. Pull plug from the socket. Operate trigger gun with safety catch several times to decrease the pressure.

Unscrew trigger gun and lance first, then rinse high pressure gun to remove possible soiling.

Check water inlet sieve for soiling.

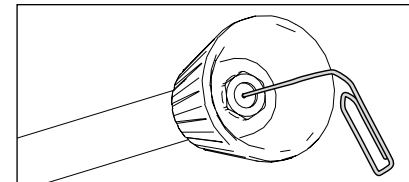

If the problem still exists, take wire (paper clip) and push through nozzle opening. If this procedure is not successful, the nozzle has to be dismantled and cleaned or even replaced, if necessary.



Pull plug from socket prior to starting any repair work!

Problem

An irregular jet comes out of the nozzle.

Cause

Most likely the valves are soiled or sticky.

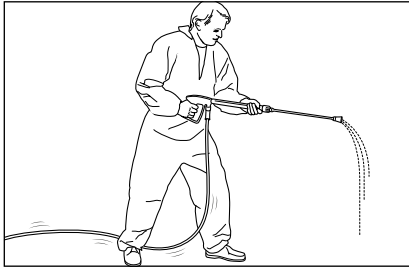

The water from the lance comes in squirts. The high-pressure hose vibrates.

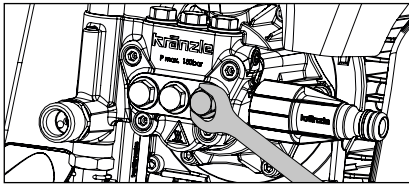

Proceeding:

Unscrew all 6 valves, one after the other (hexagonal brass screws, 3 in a row, vertically and horizontally).

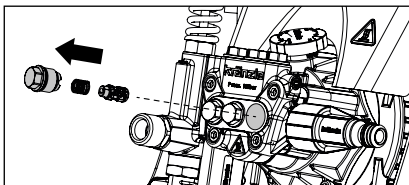

Remove the screw with valve body and spring. Check the valve body for damage. If damaged, the valve body must be replaced.

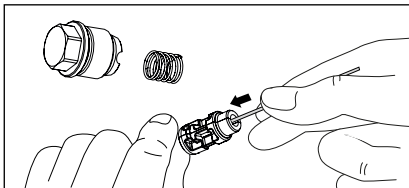

Take a wire (paper clip) and clean valves under running water.

Do not forget the O-ring during reassembly!

Problem

After closing of the trigger gun with safety catch the high pressure cleaner keeps switching on and off.

Possible cause no.1:

Leakage.

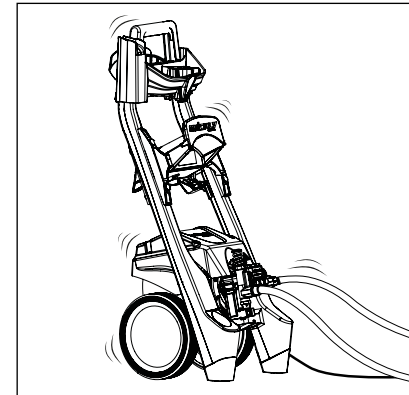

Having closed the trigger gun with safety catch, the high-pressure cleaner must shut down. Failure to shut down may be caused by leakage in the high-pressure pump, the switch, the high pressure hose, the trigger gun with safety catch or the lance.

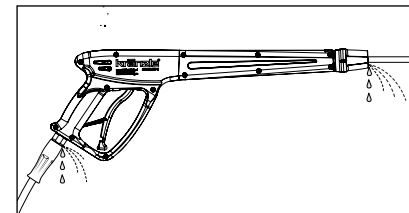

Proceeding:

Check connections from the HP cleaner to the high pressure hose and from the hose to the trigger gun and also the connection between lance and trigger gun for tightness.

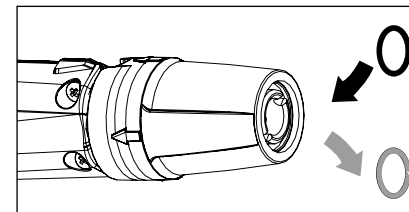

Switch off the cleaner. Shortly press the trigger of the trigger gun with safety catch to decrease the pressure. Remove high-pressure hose, trigger gun with safety catch and lance and check the O-rings. If the O-rings are damaged they have to be replaced.



In case of a leakage there is no guarantee for possible consequential damages.

Problem

After closing of the trigger gun with safety catch the high pressure cleaner keeps switching on and off.

Possible cause no. 2:

The non-return valve is defective.

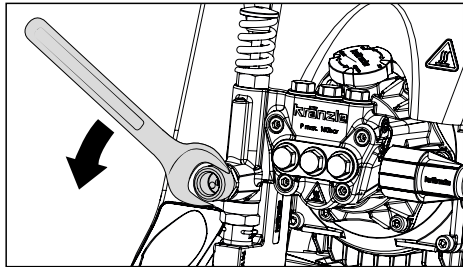

Proceeding:

Switch off the high-pressure cleaner and pull plug from socket. Cut off the water supply. Shortly press the trigger of the trigger gun with safety catch to decrease the pressure. Unscrew pump outlet.

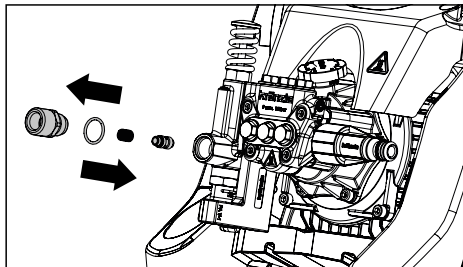

Take out check ball and check O-ring for soiling or damage. Also check stainless steel seat of ball inside the pump housing for soiling or damage.

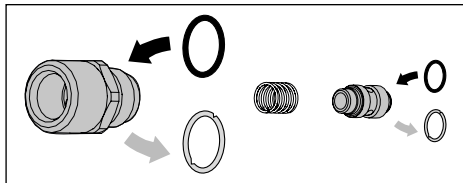

If the O-rings are damaged they have to be replaced.



There is no guarantee if the high-pressure pump is damaged by defective O-rings due to air induction or lack of water (cavitation).

We hereby declare that the design of the high pressure cleaners:

Quickly

Nominal flow: **378 l/h**

technical specifications available from:

**Josef Kränzle GmbH & Co. KG
Christopher Königsberger
Rudolf-Diesel-Str. 20, 89257 Illertissen**

comply with the following guidelines and their amendments for high pressure cleaners:

**Machinery directive 2006/42/EU
EMC-directive 2014/30/EU
ROHS-directive 2011/65/EU
Outdoor directive 2000/14/EC**

Sound level measured: **77,5 dB (A)**
Sound level guaranteed: **80 dB (A)**

Applied conformity assessment procedure:

Annex V, outdoor directive 2000/14/EC

Applied specifications and standards:

**EN 60335-1: 2012/A13: 2017
EN 60335-2-79: 2012
EN 62233: 2008
EN 55014-1: 2006+A1: 2009+A2: 2011
EN 55014-2: 2015
EN 61000-3-2: 2014
EN 61000-3-3: 2013**

Josef Kränzle GmbH & Co. KG
Rudolf-Diesel-Straße 20
89257 Illertissen (Germany)

Ludwig Kränzle
(Managing director)

Illertissen, 2025-06-05

This Kränzle high-pressure cleaner is solely designed for home users for typical applications around the house and garden (for cleaning façades, patios, garden equipment, tools, vehicles and machinery as well as building structures). It is not intended for commercial use.

The warranty obligation of Josef Kränzle GmbH & Co. KG towards the dealer from whom you have purchased this Kränzle-high-pressure cleaner (= product) applies to material faults only such as material and manufacturing defects.

Defects attributable to long and frequent use of the product, typically arising due to the age of the high-pressure cleaner and intensity of its use are defined as normal wear in respect of product components. Purchaser's rights to assert claims for such defects are ruled out. Parts subject to wear include in particular the pressure gauge, nozzle, valves, sleeves, high-pressure hose and spray equipment.

The product is to be operated in conformity with this operating manual. The operating manual is deemed to be part of the warranty provisions.

Any changes made to the safety devices of the product or instances of maloperation – such as exceeding the temperature and speed limits, undervoltage, insufficient water supply and sewage water, or failure to use the product for the intended purpose – may result in damage occurring to the product. Such damage is not deemed to constitute any material defect.

Should the use of accessories or spares other than original Kränzle component parts and original Kränzle replacement parts be the cause of defects on our product, this may lead to all warranty claims becoming null and void. Only the use of original Kränzle replacement parts matching the relevant Kränzle high-pressure cleaner provides adequate assurance for safe and trouble-free operation of the Kränzle high-pressure cleaner.

With regard to legal warranty claims, the limitation periods of the respective countries shall apply.

Where warranty claims apply to any other defects, please contact your local dealer, presenting the accessories together with your purchase receipt, or the nearest authorised service centre. This can also be found on the internet under **www.kraenzle.com**.

Floor cleaner
Round Cleaner UFO light

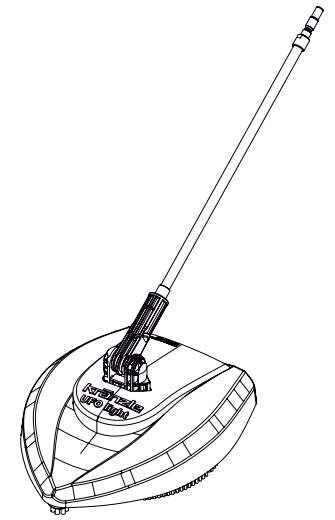

Round Cleaner UFO light

Operating pressure, max.	160 bar
Flow rate, max.	10 l/min
nozzle system	03
Temperature max.	40 °C
Weight	1,25 kg
Order no.	41870

Permissible tolerance for figures ± 5 % in acc. with VDMA uniform sheet 24411

Explanatory symbols used on the accessories

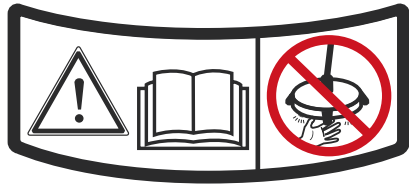

Read and observe safety instructions in the operating manual before use! There is a risk of injury from the rotating arm of the Round Cleaner UFO light. Never reach under the Round Cleaner UFO light when the high-pressure cleaner is running.

After switching off the high-pressure cleaner, the rotating arm continues to rotate for a few seconds. After switching off the high-pressure cleaner, wait until the rotating arm stops and then unplug the high-pressure cleaner from the mains before working on the Round Cleaner UFO light.

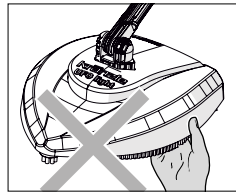

Never touch the bottom of this appliance if it is connected and ready for operation! Never touch the rotating rotor!

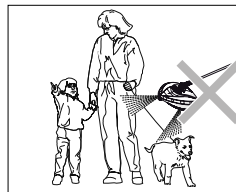

Never direct the high-pressure jet at people or animals! Never direct the high-pressure jet at yourself or other persons, not even to clean clothing or shoes.



Never allow children or untrained persons to use the Round Cleaner UFO light or to play with it! Children must be kept under supervision to prevent them from playing with the equipment.

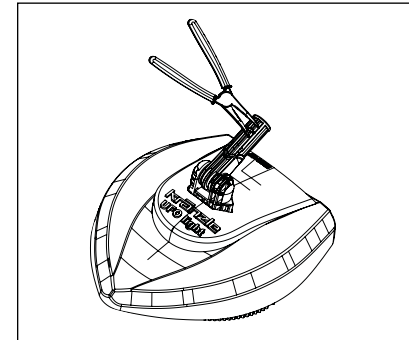

Pull out the clip with needle-nose pliers or alternatively lever out the clip with a screwdriver.

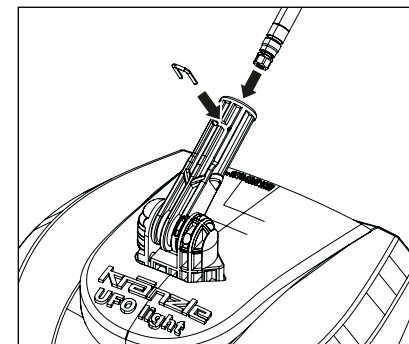
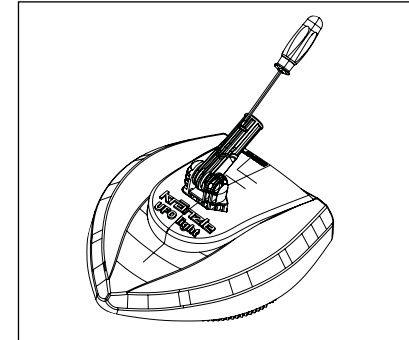

Then insert the stainless steel tube from above and then reinsert the clamp. Inserting the clamp requires some force, as it must be firmly connected to both components to ensure a firm hold.

Floor cleaning

The Round Cleaner is particularly suitable for cleaning plane surfaces like carriage gateways, terraces etc.

Mount the Round Cleaner instead of the spray lance to the high-pressure gun of your HP-cleaner. Place the Round Cleaner to a non-sensitive surface, e.g. asphalt.

When cleaning sensitive surfaces try out the Round Cleaner on a barely visible spot first. **Do not exceed max. pressure** (see technical data)



max. angle 45°

Taking out of operation

1. Switch off the high pressure cleaner
2. Cut off the water supply
3. Open the trigger gun with safety catch briefly until the pressure is released
4. Apply safety catch on the trigger gun
5. Remove Kränzle Round Cleaner
6. Check if the rotor is tangled with threads etc.
7. Use a paper clip to check if the nozzles are clogged (siehe kleine Reparaturen selbstgemacht)

Cleaning and care

Put the Round Cleaner on to the floor in such a way that the splash protection brush cannot be deformed due to rough ground.

Problem

No water comes from the nozzle but the pressure gauge shows full pressure.

Cause

Most probably the nozzle is clogged.

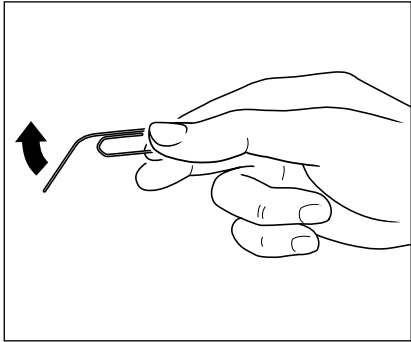

Straighten a paper clip.

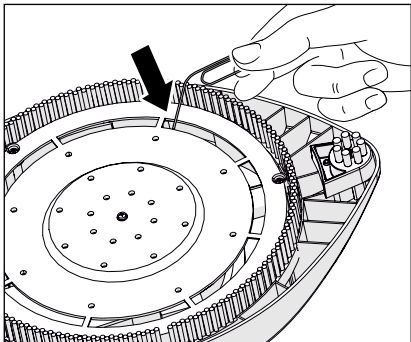

Clean the nozzle with the straightened paper clip.

Rinse the high-pressure hose.
And you can proceed with the high-pressure cleaning as before!

Warranty

Our warranty obligation is understood to exclusively cover material and manufacturing defects, wear is not covered by warranty.

The machine is to be operated in conformity with this Operating manual. The operating manual is deemed to be part of the warranty provisions. This warranty shall only apply on condition of proper use of original-Kraenzle component parts and original-Kraenzle replacement parts.

With regard to legal warranty claims, the limitation periods of the respective countries shall apply.

In the event of any warranty claims, please have your accessories and purchase voucher ready before contacting your local dealer or the nearest authorized customer service point, which you can also find in the internet under **www.kraenzle.com**.

The machine is designed for private purposes only; no warranty shall be provided in case of industrial use.

In case of any modifications on the safety installations or in case of exceeding the temperature and speed limit, any warranty claims shall become invalid - this shall also apply to use of wastewater as well as any other faulty or inappropriate operation of the machine.

Pressure gauge, nozzle, valves, sleeves, high pressure hose and spray equipment are wear parts and are not covered by the warranty obligation.

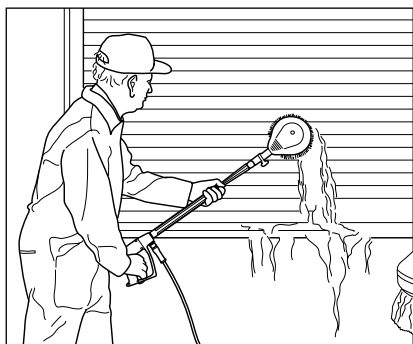

Rotating washing brush

- 210 mm
- Stainless steel extension
- Brush head Ø 180 mm
- Nozzle size 2,5 mm

Art. no.: 12800



Splash guard

- L: 280 mm x W: 190 mm
- For all washing lances

Art. no.: 132600

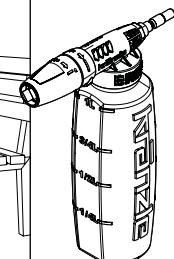
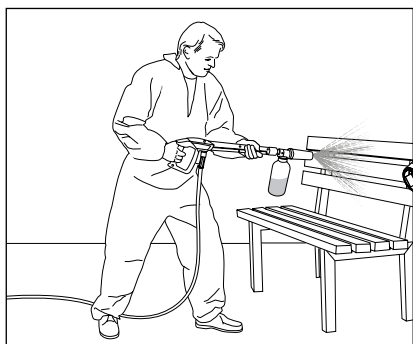

Foam lance

- with container

1 liter Art. no.: 135302
2 liters Art. no.: 135312

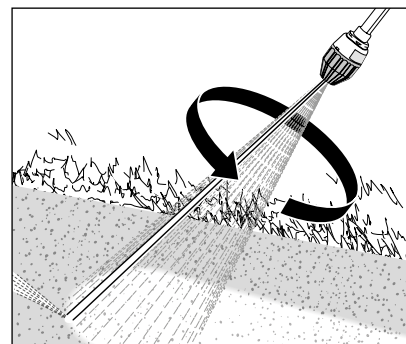

Dirtkiller lance

- 400 mm
- Nozzle system 028

Art. no.: 42403-028

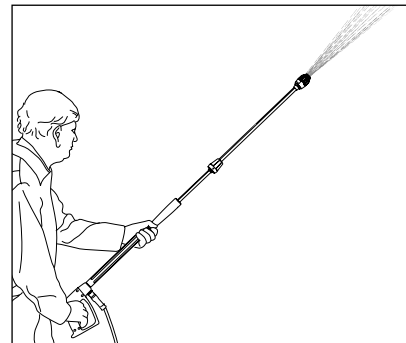

Lance extension

- 400 mm

Art. no.: 12870

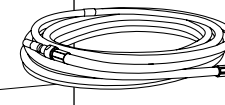
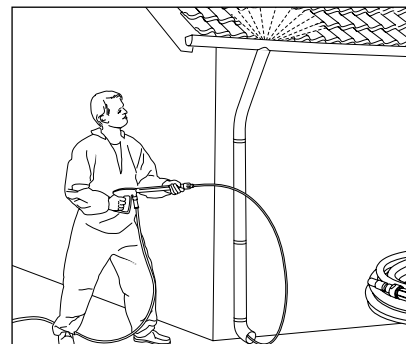

Pipe cleaning hose

- 10 m length

Art. no.: 12850



The high-pressure cleaner accessories are safety components!
Any warranty will be void if parts not authorised by Kränzle are used.



Please indicate the technical data of the high-pressure cleaner (device type) when placing your order.



Josef Kränzle GmbH & Co. KG

Rudolf-Diesel-Straße 20
89257 Illertissen (Germany)

sales@kraenzle.com

© Kranzle 10.07.2025 / Ord. no.: 306830 / Subject to technical modifications and errors.

■ **Made**
■ **in**
■ **Germany**